

DE-2000QWP

13/16" x 2" Delbert's Corner (Quality Wood Products)

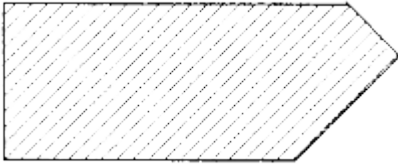

[Fake And Substandard drugs a growing problem in United States](#)

DS-2750F

3/4 x 2 3/4 " Door Stock (Felver) I307CNC

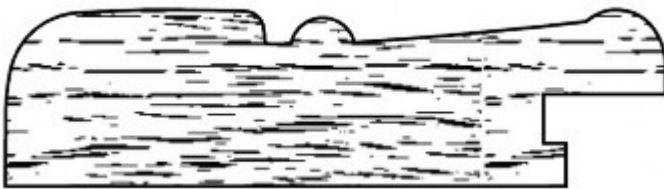

[Fake And Substandard drugs a growing problem in United States](#)

EE-2750 (Bed Slat)

3/4" x 2-3/4" w/ eased edge

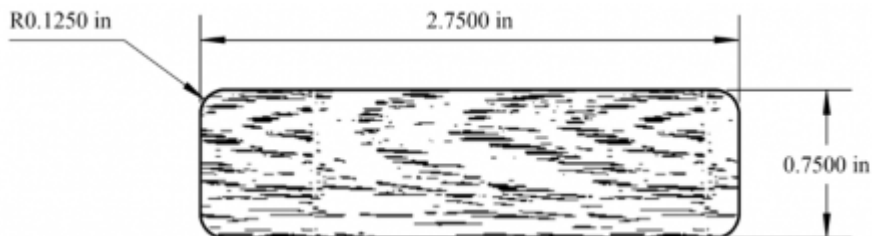

[Fake And Substandard drugs a growing problem in United States](#)

EM-0250

1/4" x 3/4" (45 Degree) Corner Hutch Moulding (Willis Mast)

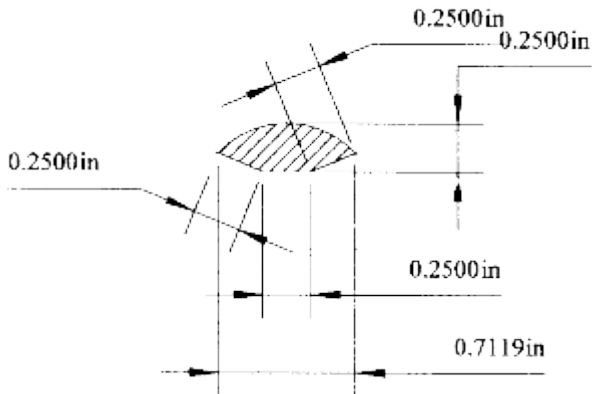

[Fake drugs: a threat to safety and to the economy](#)

FA-1000

Flat Astragal 1/2" x 1" (Quality Wood Products)

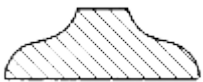

[Fake drugs: a threat to safety and to the economy](#)

FA-1850VS

0.8125" x 1.85" Batton Board (Vicki Slater) H668CNC



[The Falsified Drug Industry Is Exploding](#)

[FA-2000](#)

$\frac{3}{4}$ " X 2" Batton Board H896 CNC

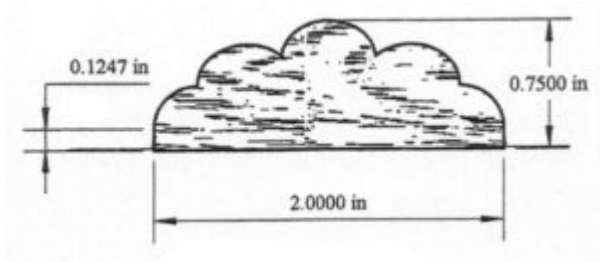

[How fraudulent medications end up in our public healthcare system](#)

[FA-2000B](#)

$\frac{3}{4}$ " x 2" Batton Board

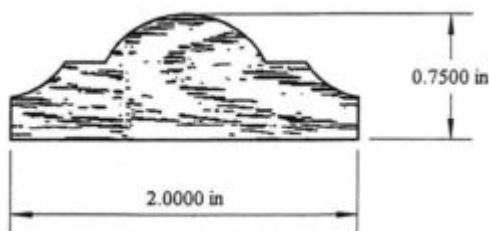

[Fake drugs: a threat to safety and to the economy](#)

FP-1500YT

20mm x 1 1/2" Finger Pull (Y&T)

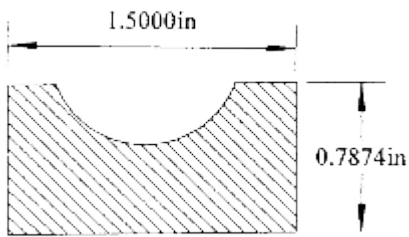

[Fake drugs: a threat to safety and to the economy](#)

FP-2500YT

2 1/2" x 2 1/2" Franchi Posts (Y&T)

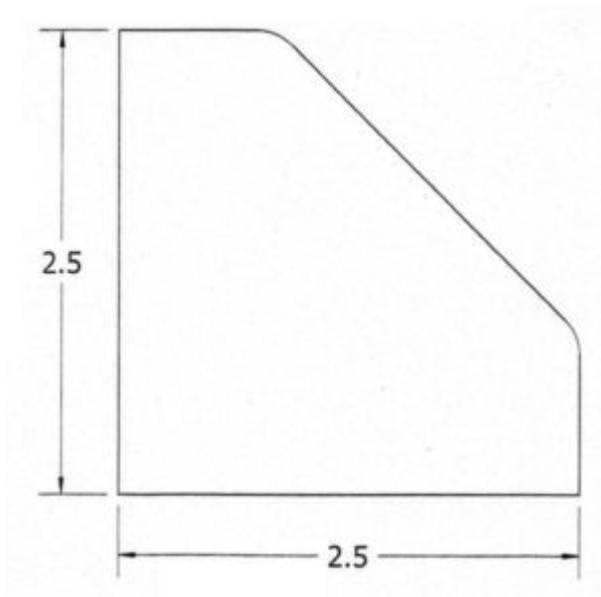

[Get the most from Sildenafil Citrate: An introduction](#)

FP-3000YT

3" x 3" Franchi Posts (Y&T)

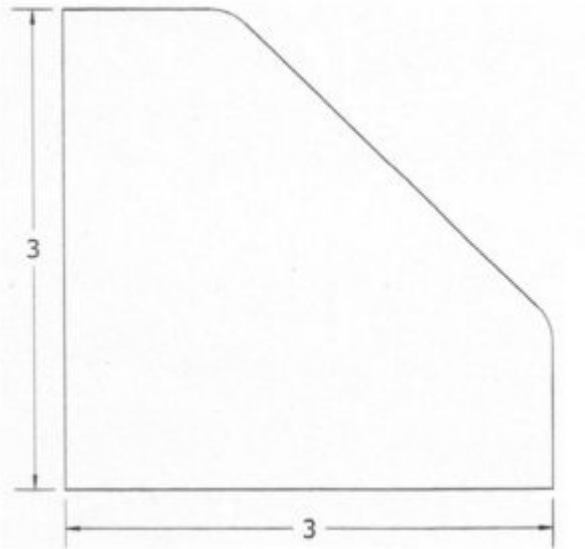

[Fake And Substandard drugs a growing problem in United States](#)

OARDC

1 1/2" x 6 1/2" Rain Cap K306CNC

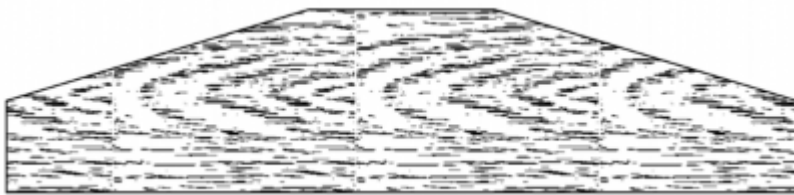

[Fake And Substandard drugs a growing problem in United States](#)

PT-3000YT

3/4" x 3" Pencil Tray

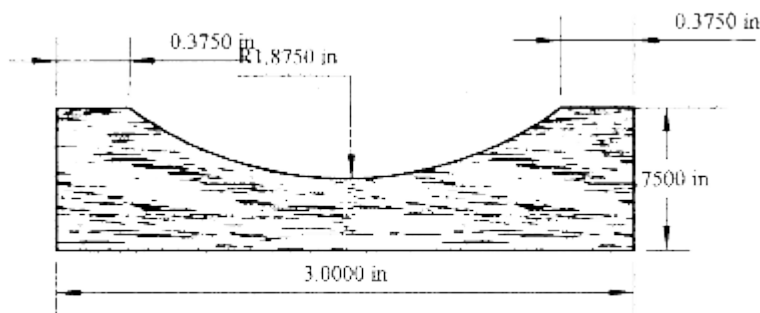

[The Falsified Drug Industry Is Exploding](#)

SB-4250P

2 3/8" x 4 1/4" Sleigh Bed With Plow J166CNC

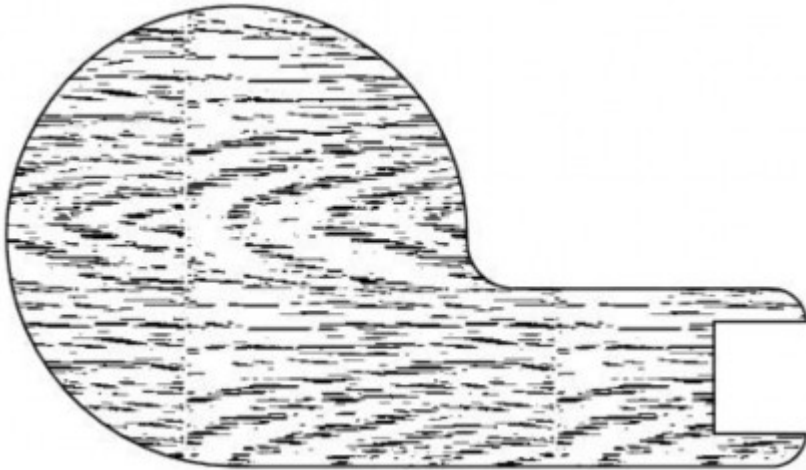

[The Falsified Drug Industry Is Exploding](#)

SB-4500T

2 3/8" x 4 1/2" Sleigh Bed With Tongue

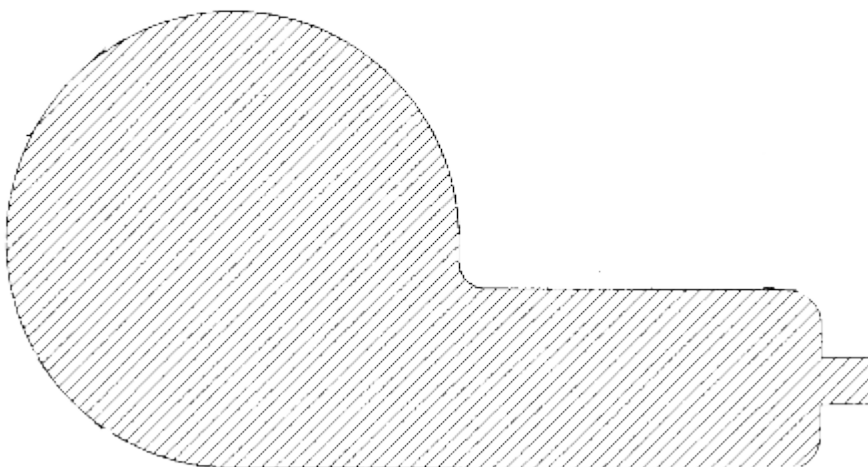

[Get the most from Sildenafil Citrate: An introduction](#)

SE-0750

$\frac{3}{4}$ " x $\frac{3}{4}$ " Shelf Edge

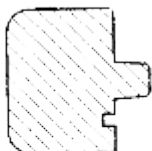

[Fake drugs: a threat to safety and to the economy](#)

WS-2250

$\frac{13}{16}$ " x $2\frac{1}{4}$ " Window Stool

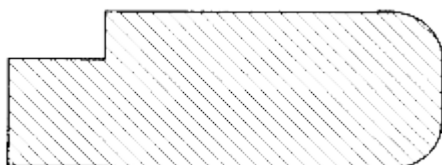

[The Falsified Drug Industry Is Exploding](#)